



Official Golden State Kickball Rulebook

Copyright © 2014-2018 by Golden State Kickball, LLC. All rights reserved.

LICENSE FOR USE

This license governs the use, redistribution, and/or republication of all or any part of the text containing the copyright notice above, in written or any other tangible form, with or without modification, which is permitted provided that the following conditions are met:

1. Replication, redistribution, or reprint of all or any part of the Official Golden State Kickball Rulebook ("Rules") must retain the above copyright notice, this list of conditions, and the following disclaimer:

THESE RULES ARE PROVIDED BY THE AUTHOR "AS IS" AND ANY EXPRESS OR IMPLIED WARRANTIES, INCLUDING, BUT NOT LIMITED TO, THE IMPLIED WARRANTIES OF MERCHANTABILITY AND FITNESS FOR A PARTICULAR PURPOSE ARE DISCLAIMED. IN NO EVENT SHALL GOLDEN STATE KICKBALL, LLC, IT'S OFFICERS, DIRECTORS, EMPLOYEES, ASSIGNS OR OTHER CONTRIBUTORS BE LIABLE FOR ANY DIRECT, INDIRECT, INCIDENTAL, SPECIAL, EXEMPLARY, OR CONSEQUENTIAL DAMAGES (INCLUDING, BUT NOT LIMITED TO, PROCUREMENT OF SUBSTITUTE GOODS OR SERVICES; LOSS OF USE, DATA OR PROFITS; BUSINESS INTERRUPTION; OR PERSONAL INJURY) HOWEVER CAUSED AND ON ANY THEORY OF LIABILITY, WHETHER IN CONTRACT, STRICT LIABILITY, OR TORT (INCLUDING NEGLIGENCE OR OTHERWISE) ARISING IN ANY WAY OUT OF THE USE OF THE RULES, EVEN IF ADVISED OF THE POSSIBILITY OF SUCH DAMAGE.

1. Field and Equipment

1.1 Field

- 1.1.1 Field will be set up per the field diagram, See (Diagram 1)
- 1.1.2 Field should be set up on a flat grass or dirt surface
- 1.1.3 Bases, Cones, and / or chalk will be provided to denote foul lines and base paths

1.2 Player Equipment

- 1.2.1 Players are not allowed to wear metal cleats
- 1.2.2 Players are encouraged to wear their league supplied shirt for all games
- 1.2.3 Alternate clothing may be worn with the following restrictions
 - 1.2.3.1 Any offensive or unsafe clothing as deemed by the referee must be removed
 - 1.2.3.2 If a player refuses to remove the alternative clothing they may be ejected and/or suspended from the league as determined by the league commissioner.

2. Team Lineups

2.1 Eligibility

- 2.1.1 All players must be 21 years of age or older
- 2.1.2 All players must have registered and been placed on a team
- 2.1.3 All players must sign the injury liability waiver
- 2.1.4 Teams must be able to field a team at the start of game time, or else they will forfeit (see rule 2.7)
- 2.1.5 If a team uses any ineligible players they will immediately forfeit
- 2.1.5.1 Using ineligible players may result in additional penalties as seen fit by the league commissioner

2.2 Offensive Lineup

- 2.2.1 All players on a team must be placed in the kicking lineup
 - 2.2.1.1 Teams need a minimum of 4 players of each gender.
 - 2.2.1.2 An out is recorded at the end of the kicking order for every player short of Rule 2.2.1.1 when the spot in the lineup is eligible to kick
- 2.2.2 Teams must have a written kicking order made before the start of the game
 - 2.2.2.1 Players who arrive late may be added to end of the kicking lineup. These additions must be announced to the referee and opposing team captain
 - 2.2.2.2 A copy of the team's kicking order is to be made available to the opposing team captain

2.3 Defensive Lineups

- 2.3.1 A team may field a maximum of 10 players
 - 2.3.1.1 Plus One Ratio (Regular Season) - If unable to recruit from other teams

- 2.3.1.1.1 A team may have a maximum of 5 of each gender on the field (10 total)
- 2.3.1.1.2 A team can play with 4 of one gender and 5 of the other, if they cannot recruit another registered player (9 total in the field)
- 2.3.1.1.3 A team can also play with 4 of one gender and 3 of the other, with 7 total players in the field
- 2.3.1.1.4 If a team has fewer than 3 players of either gender, they will forfeit that game
- 2.3.1.1.5 Teams will **not** be punished with an out if they are down players in the field
- 2.3.1.1.6 Teams are allowed to pick up other **registered** players if they are short
- 2.3.2 Substitutions may be made freely in between innings, however a player may only leave the field in the middle of a defensive inning due to injury.
- 2.3.3 Teams may field 1 pitcher and 1 catcher each inning

2.4 Injury Guidelines

- 2.4.1 Timeout may be called by a Team Captain or Referee once play is dead for injuries or illness
- 2.4.2 An injured player may be substituted on defense at any time as long as a) a team has the required number of players on the field (see rule 2.7) and b) they do not return to the field for the rest of that inning
- 2.4.3 If an injured player does not take their designated kick in the kicking order, they are deemed removed from the game and cannot return. Their place in the kicking order is removed but doesn't NOT count as an automatic out.
- 2.4.4 If an injury causes a team to fall below the minimum number of total players required for eligibility they do not forfeit and may continue to play with fewer players (see Rule 2.7)

2.5 Ejections

- 2.5.1 If ejected from a game by the Referee, a player is removed from the kicking order and may not take the field on defense
- 2.5.2 If losing an ejected player causes a team to fall below the minimum number of total players or females, the affected team will forfeit the game
- 2.5.3 An ejected player may suffer additional penalties as deemed by the league commissioner

2.6 Sportsmanship

- 2.6.1 All players and spectators are expected to conduct themselves in a sportsmanlike and respectful manner as deemed by the Referee.
 - 2.6.1.1 Fighting, verbal abuse/threats will result in immediate ejection from the game. If the individual is are involved in another incident, their membership in GSK will be permanently revoked.
 - 2.6.1.2 Taunting will result in a warning issued to the entire team. A second violation, by any member of the team, will result in a run awarded to the opposing team. A third violation, by any member of the team, will result in forfeiture of the game.
- 2.6.2 Conduct including (but not limited to) fighting, verbal abuse, taunting, lewd behavior, stalling or otherwise devious tactics will not be tolerated.
- 2.6.3 Arguing with a Referee will not be tolerated. A warning will be given to any player before an ejection is called
- 2.6.4 Only Team Captains are allowed to discuss game rulings with the Referee

2.7 Forfeits

- 2.7.1 If a team is unable to field a team by the scheduled game time they are given a forfeit by the Referee UNLESS
- 2.7.2 A team may recruit other eligible and registered players, at the discretion of the Referee and opposing Team Captain, to bring them to 10 total players OR
- 2.7.3 A team may play short, but must take an automatic out at the bottom of their lineup for each amount of players they are under (Also see Rule 2.2.1.2)
- 2.7.4 Recruited players must be placed at the bottom of the team's lineup
- 2.7.5 If this is done, the Referee and opposing Team Captain must be informed.

3. Gameplay

3.1 Game Length

- 3.1.1 Regular Season Games shall last 6 innings or 75 minutes, whichever comes first.
- 3.1.2 No new innings shall be started within the final 10 minutes of game time.
- 3.1.3 Games shall always finish with a complete inning.
- 3.1.4 If 4 innings have been played and game is called for unforeseen circumstances (i.e. Darkness, weather, etc.), game shall revert to score of last complete inning and will end.
- 3.1.5 If a team leads by 5 or more runs going into the top of the final inning, then they can score a maximum of 5 runs.
- 3.1.6 If a team leads by fewer than 5 runs, the maximum lead at the end of the top of the inning is 10 runs.

3.2 Outs

- 3.2.1 A team continues to kick until 3 Outs are recorded or 5 runs have been scored. Exception is the Final inning (see Rule 3.1.5 AND 3.1.6)
- 3.2.2 Fouls and Strikes are independent of one another
 - 3.2.2.1 After a kicker receives a count of 3 strikes they are out
 - 3.2.2.2 After a kicker receives a count of 3 fouls they are out
- 3.2.3 Any ball contacted by the kicker that is caught in the air before touching the ground by a defender is an out
- 3.2.4 A kicker or base runner who contacts a ball in fair territory outside the kicking box (see Diagram 1) before a defender touches the ball is out
 - 3.2.4.1 If this occurs the ball is immediately dead and base runners return to the last base they had safely reached
 - 3.2.4.2 If a kicked ball hits a base runner while they are still on the base they are forced to vacate, the ball is dead, the base runner is out and the kicker advances to first base. Any other base runners return the last base they had safely reached, advancing 1 base if forced. If a kicked ball hits a base runner while they are still on the base they are NOT forced to vacate, the ball is live, the base runner is safe.
- 3.2.5 If a fielder contacts a base runner who is not on base (except when overrunning first base) with the ball via throw or tag the base runner is out
 - 3.2.5.1 If a thrown ball contacts a base runner's head or neck (except when sliding), the play is deemed dead and the base runner is awarded the base to which they were advancing.

- 3.2.6 A fielder in control of the ball who touches a base before a forced baserunner arrives records an out
- 3.2.7 Any base runner running more than 4 feet outside the baseline is out
- 3.2.8 Any base runner who intentionally interferes with a fielder while making a play on the ball is out, play is considered dead and runner returns to base they last touched.
- 3.2.9 If a base runner is not standing on a base when the ball is kicked they are out
- 3.2.10 Any base runner passing another base runner is out
- 3.2.11 If a player does not kick in their designated spot in the order, they are out
- 3.2.12 Any Base Coach or offensive player not on base or kicking interfering with play will cause the affected base runner / kicker to be called out
- 3.2.13 If a kicker touches a pitched ball with their hands they will be issued one verbal warning. Subsequent violations will result in a dead ball out on which no runners advance

3.3 Pitching

3.3.1 Pitching Delivery

- 3.3.1.1 The pitcher must plant his foot behind the pitching mound within one foot to either side of the mound when delivering his / her pitch
- 3.3.1.2 The kicker must keep one foot within the kicking box prior to and during the pitch delivery.

3.3.2 Strikes

- 3.3.2.1 3 Strikes and a kicker is out
- 3.3.2.2 The strike zone is 30" wide and is marked by two standard bases
- 3.3.2.3 The strike zone is 12" high
- 3.3.2.4 A pitched ball is a strike if:
 - 3.3.2.4.1 The pitched ball bounces twice
 - 3.3.2.4.2 Any portion of the ball passes through the volume of the strike zone as the ball crosses home plate (see Diagram 2)
- 3.3.2.5 Paint, chalk, or bases may be used to designate home plate
- 3.3.2.6 A kicker that makes an attempt to kick the ball (as determined by the referee) but does not make contact is given a strike.

3.3.3 Fouls

- 3.3.3.1 Three Fouls and a kicker is out
- 3.3.3.2 A ball contacted by a kicker when ANY part of their plant foot is outside of the kicking box is a foul
- 3.3.3.3 A ball contacted from the hip or higher by the kicker is a foul
- 3.3.3.4 A ball contacted more than once by the Kicker while in the kicking box is a foul
- 3.3.3.5 A kicked ball is foul if:
 - 3.3.3.5.1 It lands in foul territory between home and first base or between home and third base
 - 3.3.3.5.2 It passes first or third base on foul territory
 - 3.3.3.5.3 It lands on foul territory beyond first or third base
 - 3.3.3.5.4 It is over foul territory and is touched by an umpire or player or any object foreign to the natural ground (regardless of that person or object's position on the field)
 - 3.3.3.5.5 See Diagram 3 for fair and foul ball examples

- 3.3.3.6 Cones, chalk, or paint should be used to designate foul lines
- 3.3.3.7 A foul ball is live until it touches the ground and base runners may tag up if a fly ball is caught in foul territory

3.3.4 Balls

- 3.3.4.1 Four balls and a kicker is walked
 - 3.3.4.1.1 A kicker may be intentionally walked at any time by declaring the walk to the Referee
 - 3.3.4.1.2 No pitches need to be thrown when intentionally walking a kicker
- 3.3.4.2 A ball is a pitch that is neither a strike nor a foul
- 3.3.4.3 If the ball bounces only once before touching the plate it is a ball

3.4 Catching

- 3.4.1 The Catcher is the only defender who may start play in foul territory
- 3.4.2 The Catcher may not at any time touch the kicker or obstruct their kick in anyway
- 3.4.3 The Catcher must always stay outside the kicking box until the ball is kicked
 - 3.4.3.1 If the Catcher interferes with the kicker in the act of kicking or in proceeding to first base the play is dead and kicker is automatically awarded first base
 - 3.4.3.2 Catcher can line up as wide as they want, as long as the don't break the plane of the box or the perpendicular line extending from the box, denoted by the cone

3.5 Fielding

- 3.5.1 All Defenders, except the Catcher, must be in fair territory when the ball is pitched
- 3.5.2 Fielders may not at any time obstruct a base runner's path to their next base
 - 3.5.2.1 Fielders may not set up in the baseline or on a base before the ball is pitched
 - 3.5.2.2 Fielders may not physically make contact with the base runner at any time (they may tag to runner with the ball only)
- 3.5.3 Fielders may not intentionally block a base, including home while not in possession of the ball. There must be a clear path for the runner to reach the base.
 - 3.5.3.1 A Referee will signal obstruction at the point it occurs.
 - 3.5.3.1.1 If the obstruction causes the base runner / kicker to be called out the play is immediately dead and all base runners advance to the next base.
 - 3.5.3.1.2 If the obstruction did not cause any base runners to be called out all base runners are allowed one extra base once the play is dead

3.5.4 Overthrows/Popped Ball

- 3.5.4.1 An Overthrow is defined as an errant attempt to throw to a defensive player in position to make a defensive play.
- 3.5.4.2 On an overthrow, the ball is deemed dead when it hits the fence or goes further than 20 feet in foul territory from the closest base. All runners are awarded one extra base, regardless of intent to advance or not.
 - 3.5.4.2.1 An attempt to hit the base runner with the ball is not considered an Overthrow and is still considered live.
 - 3.5.4.2.2 If a throw contacts a base runner, ball is still considered live.

3.5.5 During any play in which the ball is popped, deflates, or in anyway is noticeably altered, that play shall be ruled dead and replayed with a properly inflated ball.

3.6 Encroachment

3.6.1 Before the ball is kicked no Defender, including the Pitcher, may enter fair territory in front of the imaginary line made from 1st to 3rd

3.6.2 A team will be issued one warning before receiving a penalty for encroachment

3.6.3 A Referee will signal encroachment at the time it occurs

3.6.3.1 After the play is resolved the kicking team captain may choose to a) accept the result of the play OR b) have the pitch count as a ball, and have all base runners advance 1 base from their position at the start of the play OR c) If no runner is on base, kicker has the option of going to second base.

3.7 Baserunning

3.7.1 A Baserunner may not leave their current base until the ball is kicked

3.7.1.1 No stealing or leading off is allowed

3.7.1.2 If a Baserunner is off the base when a ball is kicked they will immediately be called out

3.7.2 A Baserunner must stay within 4' of the baseline

3.7.2.1 A Baserunner has priority to the base path area of the field unless a Defender is actively making a play on the ball

3.7.3 A Baserunner may not interfere in any way with a Defender making a play on the ball. This includes touching, obstructing, yelling, intentionally touching the ball, or any other action at the discretion of the Referee which obstructs play. A baserunner who obstructs a fielder will be immediately called out

3.7.3.1 A Baserunner must avoid colliding with a defender when advancing to a base. Intentionally colliding with a Defender will cause the Baserunner to immediately be called out and subject to ejection from the game

3.7.4 Baserunning at 1st Base

3.7.4 A Baserunner may run past 1st base after kicking.

3.7.4.1 Baserunners doing so must run past the base in a straight line and return to the base immediately

3.7.4.2 If the Baserunner at any time makes an advance towards 2nd base, they may be tagged out before returning to a base

3.7.5 All Baserunners must touch the safety base when ONLY advancing to 1st base.
If the referee determines interference:

3.7.5.1 Offending team receives a total of two warnings /reminders to run to the safety base

3.7.5.2 On third overall infraction, referee can call an automatic out, which will be announced to both teams.

3.7.5.3 Each infraction thereafter will result in an automatic out for the offending team

3.7.6 Tagging Up on Fly Balls

3.7.6.1 A Baserunner may only advance on a caught fly ball once they tag-up

3.7.6.2 A Baserunner must remaining on their starting base until a Defender touches (not catches) a fly ball

3.7.6.3 A Baserunner who does not return to their starting base when a fly ball is caught will be called out if the Defending team tags the runner with the ball or tags the starting base the runner occupied.

3.7.7 Pitcher Obtains Possession of Ball

3.7.7.1 The ball is dead and the play is over once the pitcher has the ball on the pitcher's mound.

3.7.7.1.1 Any baserunner more than halfway to the next base is allowed to advance.

3.7.7.1.2 Any baserunner halfway or less to the next base is allowed to return to the previous base safely.

3.8 Interference

3.8.1 Any interference with the ball in play results in a dead ball. The play is immediately over.

3.8.2 Any person, not playing or refereeing the game, contacting the live ball or hindering the fielder results in interference.

3.8.3 Any object, that is not part of the Field (see 1.1), contacting the live ball or hindering the fielder results in interference.

3.8.4 If a Fielder throws or kicks the ball, and it makes contact with a player from the defensive team who is not in the field in that inning, the play is declared dead, and the runners all advance to the next base, regardless of an attempt to that base.

3.8.4.1 If the above occurs, but the ball strikes an offensive player currently uninvolved with the play AND that play was not already deemed an overthrow (i.e. base coach or player in dugout), the ball is dead and runners must retreat to the prior base. If the struck person is deemed to have intentionally touched the ball, the play is declared dead, the nearest runner is called out, and other runners must retreat to the previous base.

3.8.5 If a Fielder throws the ball into foul territory and out of play as deemed by the Referee, the play is called dead and all Baserunners advance ONE additional base beyond the base they were advancing towards.

3.9 Team Referees

3.9.1 Each team must provide at least two players to referee 1st and 3rd Base

Penalties for missing referee assignments are as follows:

3.9.0.1 1st Offense - Start next week's game down a run

3.9.0.2 2nd Offense - Start next week's game down two runs

3.9.0.3 3rd Offense - Banned from Tournament

3.9.0.4 If referee assignment is missed by team in the last week of regular season play, the penalty will occur in the first game that team plays in the tournament (that is not a forfeit)

4.0 Tournament Play

4.0.1 All tournament games will be 6 innings, regardless of time length

4.0.1.1 A tournament game may not end with a tie and will continue beyond 6 innings until a team has won

Uneven Ratio Rule

4.0.2.1 If a team has fewer than 5 of each gender, they will take one out at the top of the lineup per that gender that is missing

- 4.0.2.1.1 If a team has 4 of one gender and 5 of another, they will take one out
- 4.0.2.1.2 If a team has 3 of one gender and 5 of another, they will take two outs
- 4.0.2.1.3 If a team has 3 of one gender and 4 of another, they will take two outs
- 4.0.2.3 There must be an equal gender distribution in the field (5 and 5, 4 and 4, 3 and 3)
- 4.0.2.3.1 If there are fewer than 3 of one gender, the team will forfeit the game
- 4.0.2.3.2 Teams cannot play with fewer than 6 players on the field

Team Tournament Refing

- 4.0.3.1 Teams assigned to ref must have 1 first base and 1 third base referees
- 4.0.3.2 If a team is missing 1 referee, in their next game, they must play the 1st kicking inning down 2 outs
- 4.0.3.3 If a team is missing both referees, in their next game, they will forfeit kicking the whole first inning

DIAGRAM 1 GSK FIELD DIMENSIONS

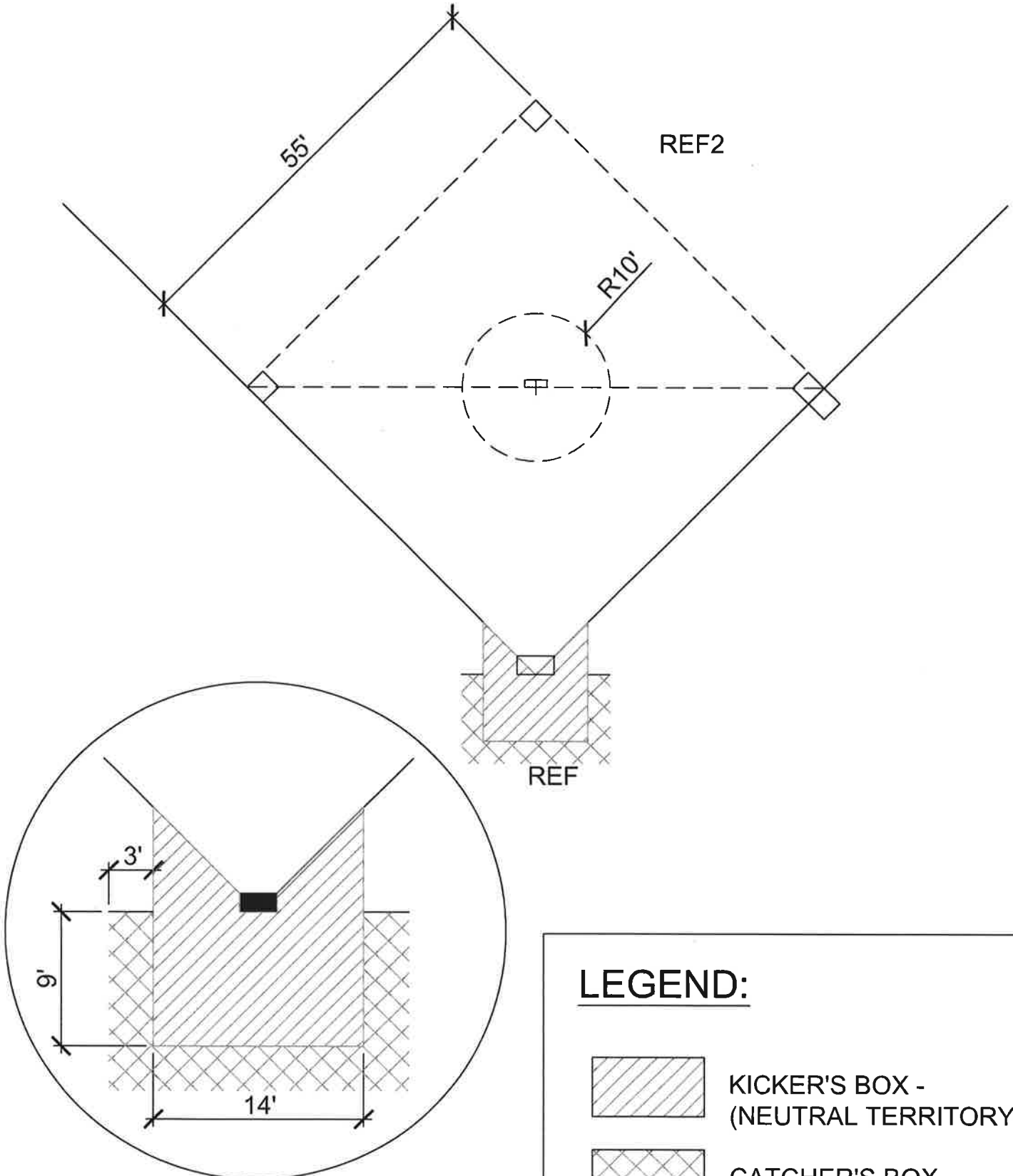

ENLARGEMENT OF HOMEPLATE AREA

LEGEND:



	KICKER'S BOX - (NEUTRAL TERRITORY)
	CATCHER'S BOX

DIAGRAM 2
GSK STRIKE ZONE



ANY PART OF THE BALL PASSING THROUGH
ANY PART OF THE STRIKE ZONE, AFTER
BOUNCING TWICE, IS CONSIDERED A STRIKE.

DIAGRAM 3

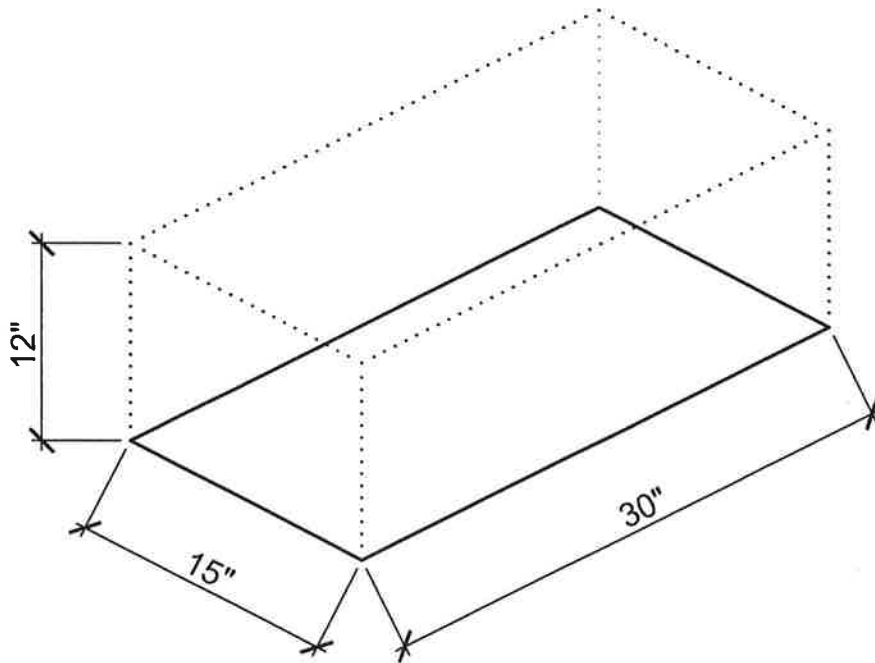
GSK FAIR / FOUL EXAMPLES

FAIR FLY BALLS

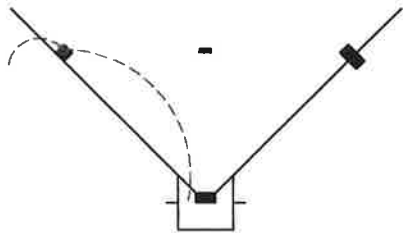

EXAMPLE 'A'

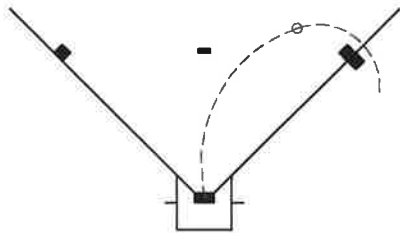

EXAMPLE 'B'

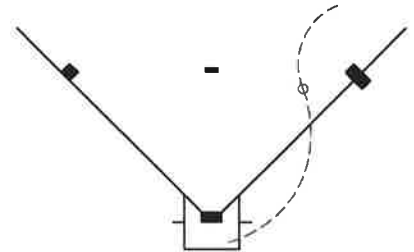

EXAMPLE 'C'

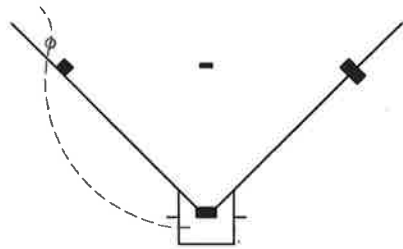

EXAMPLE 'D'

FAIR GROUND BALLS

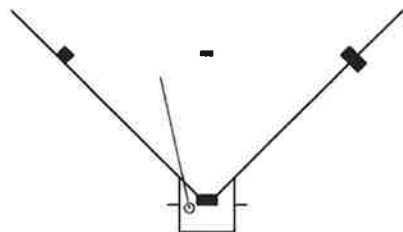

EXAMPLE 'E'

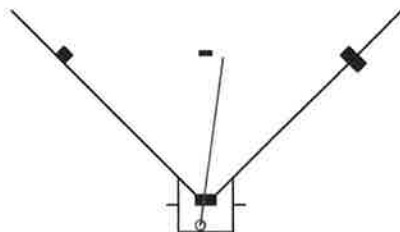

EXAMPLE 'F'

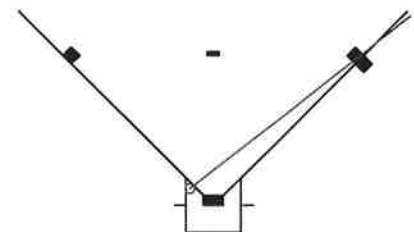

EXAMPLE 'G'

LEGEND:



-  PATH OF BALL IN AIR
-  PATH OF BALL ON GROUND
-  FIRST CONTACT POINT WITH GROUND

DIAGRAM 3 GSK FAIR / FOUL EXAMPLES

FOUL FLY BALLS

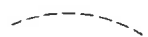

EXAMPLE 'H'

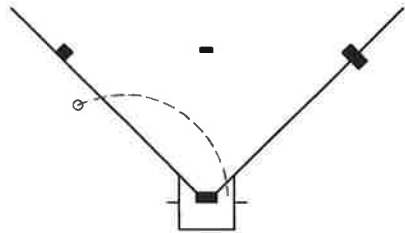
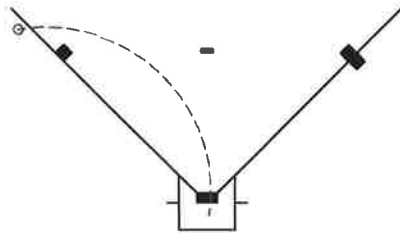

EXAMPLE 'I'

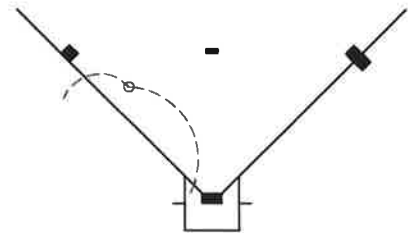

EXAMPLE 'J'

FOUL GROUND BALLS

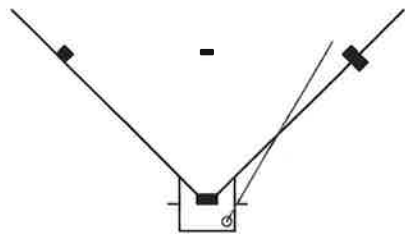

EXAMPLE 'K'

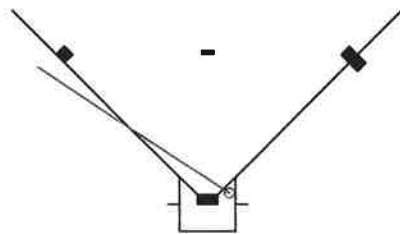

EXAMPLE 'L'

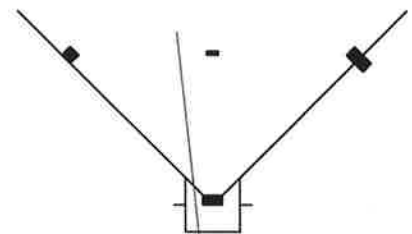

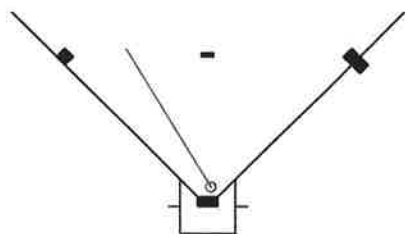

EXAMPLE 'M'

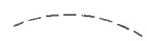

EXAMPLE 'N'

LEGEND:

-  PATH OF BALL IN AIR
-  PATH OF BALL ON GROUND
-  FIRST CONTACT POINT WITH GROUND